

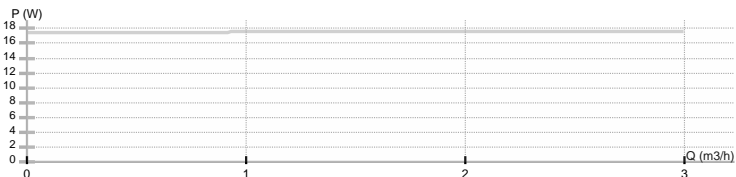

NMT MINI 20/40-180

NMT MINI

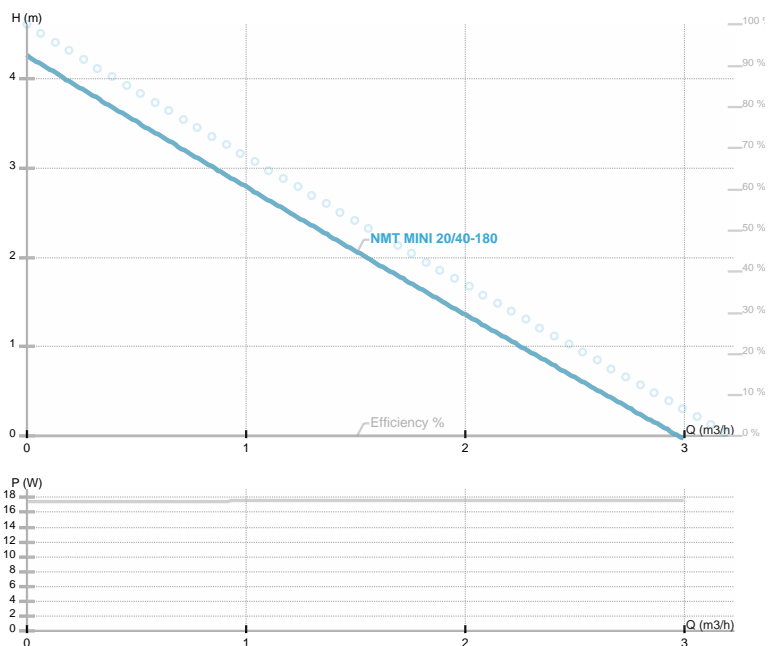

Part number	979525366
Power supply	1~230 V
Declared protection	IP44
Q max	3.1 [m³/h]
H max	4.0 [m]
RPM	4000 [1/min]
Motor power	20 [w]
Declared current	0.17 [A]
Fluid	Water VDI 2035, glycol 40%
Fluid temperature	-10.0 ÷ 110.0 [°C]
Insulation class	F
DN	20 [mm]
Connector	Rp 3/4
Net weight	1.66 [kg]
Length	180 [mm]
Approvals	
EEL	0.14
Efficiency	51 [%]
Impeller material	Noryl Fe 1630PW
Bearing material	all carbon
Shaft material	AISI 420
Hydraulics material	Gray cast iron
Mains frequency	50/60 Hz
Connection	Rp 3/4
Max pressure	1.0 MPa
Ambient temp.range	40 deg C

Drawing

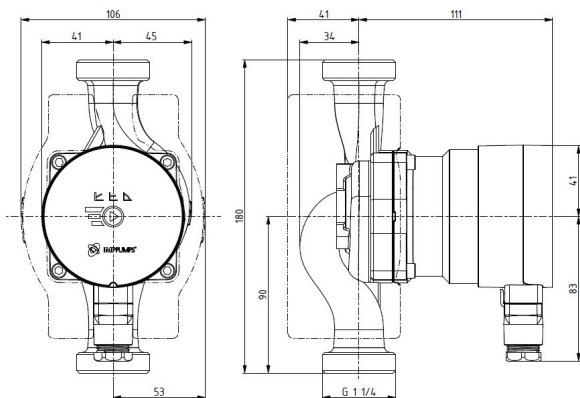

Electrical wiring

